

# OXFORD SHINGLE

*Distinctive Low-Profile Aluminum Roofing*

## INSTALLATION INSTRUCTIONS

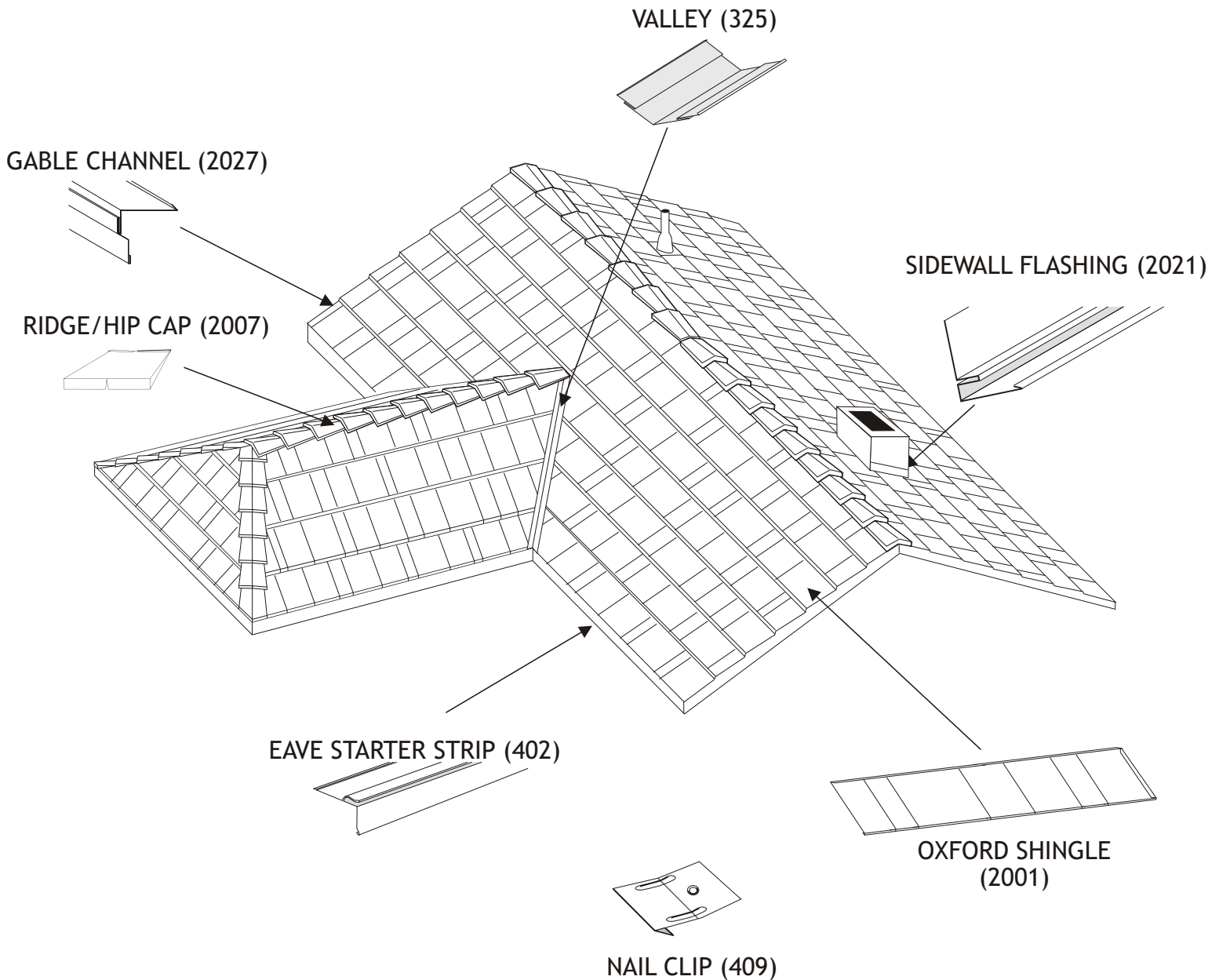

**CLASSIC  
PRODUCTS**  
INC.

**For any installation questions, call the manufacturer at 1-800-543-8938.**

## GENERAL GUIDELINES

Use only accessories supplied by Classic Products, with matching finish. Do not combine dissimilar metal parts with these metal roofing systems. Insulate metal flashings from contact with existing metal or masonry with a coating of roofing cement and a layer of roofing underlayment.

Most lineal flashings have a return flange, which is part of a channel for water to drain under the shingles. Be careful not to flatten this return flange. No nails should penetrate the flashing within this channel area. Fasten these flashings to the roof with Nail Clips (SH-409) 12" on center.

Uphill flashings should nest inside or lap downhill by 3" and be sealed with Terpolymer Butyl Sealant (VP-275) in matching colors or clear.

Minimum pitch is 3:12. On steep installations, distribute weight loads by placing planks under ladders or other scaffolding used on the roof.

## Installation Sequence

1. Prepare roof and apply underlayment.
2. Install **EAVE DRIP EDGE**.
3. Install **GABLE EDGE TRIM, VALLEY** and **SIDEWALL FLASHING**
4. Install **SHINGLES**, left to right, eave to ridge.
5. Install **RIDGE/HIP CAPS** as needed.

## Roof Preparation

Oxford Shingle may be installed over solid sheathing, or old composition shingles which are in good condition without curling or deformation. To prepare for reroofing, nail down any loose or curled shingles and protruding nails, cut off overhanging shingles from eaves and gables and remove any ridge or hip caps. Sweep the roof clean. Oxford Shingle may not be installed over wood shakes or shingles, tile, cement shakes, or metal.

## Underlayment

Underlayment should be a minimum of one layer of 30-pound felt, one layer of SP-6000 RoofGuard, or one layer of Elk VersaShield. Cover entire roof with underlayment, from left to right, eave to ridge. Allow underlayment to overhang eaves by 1½", and extend up all pipes, chimneys and sidewalls by 1½". Lap head and end joints 18", lap successive courses 6". Run additional underlayment lengthwise up all valleys and hips and against all sidewalls. Nail underlayment 12" on centers using Plastic-Top Felt Nails (N-501). In areas with heavy ice and snow potential, use ice & water shield or similar underlayment above overhanging eaves plus two feet past exterior wall line.

## Drip Edge (402)

Install Drip Edge on all eaves. Underlayment should extend 1½" down onto fascia beneath the Drip Edge. Nail Drip Edge to roof deck 12" on centers. Gutters should be installed behind the overhanging underlayment and the Drip Edge.

## Gable Channel (2027)

Install Gable Channel on all gable ends. Underlayment should extend 1½" onto fascia beneath Gable Channel. Gable Channel should overlap Drip Edge at the eave and be plumb-cut flush. Fasten Gable Channel to roof deck using Nail Clips (SH-409) 12" on centers. Uphill pieces should lap downhill pieces by at least 3".

## Oxford Shingle (2001)

Shingles are installed from left to right, eave to ridge. Begin the first shingle by inserting into the left trimpiece. Remove the butt of the first shingle that covers the end of the water return channel. Lock the bottom edge of the shingle into the Drip Edge. Each shingle receives five nail clips (or one clip for every foot of shingle). Succeeding shingles lock into the side lock of the previously-installed shingle and proceed on a parallel course from left to right. The bottom lock of the next course of shingles is locked into the top lock of the shingles below. Successive courses of shingles are staggered as follows: full shingle, 50", 30", 20", 48", 34" and 13", repeat. Remember to maintain this stagger with each new course of shingles you begin, be it at a gable, valley, hip, or sidewall.

When a shingle is installed into a Gable Channel, temporarily set a shingle over the Gable Channel, maintaining appropriate stagger. Mark the shingle where it crosses over the groove of the Gable Channel and about 2" past the edge of the roof. Remove the excess material.

Cut the top lock and the bottom locks at the groove marks and fold the locks open. Bend the end of the shingle down 90 degrees. The newly formed side lock should be about 1 ¾" long. Insert the side lock into the groove of the gable channel. If the side lock is too long, it may keep the shingle from resting flat against the deck. If necessary, remove some of the side lock so the shingle rests flat on the deck. When the shingle is correctly formed, lock it in place and fasten it to the deck with nail clips.

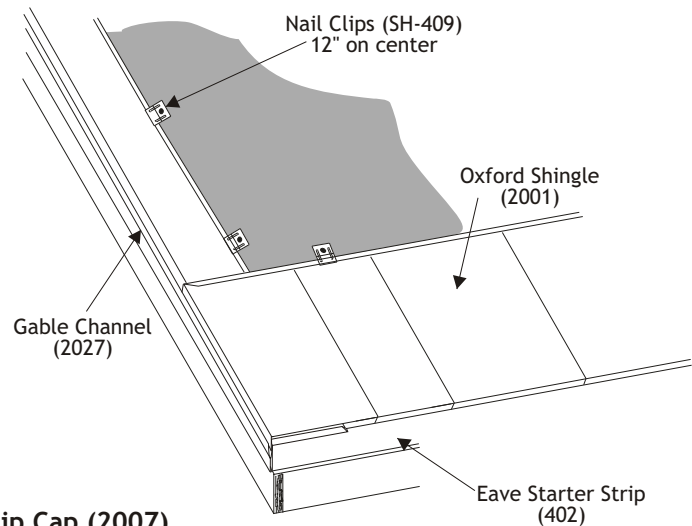

## Hip Cap (2007)

Cut the panels to the hip angle so that the gap at the ridgeline is minimal and secure into place.

For the first cap on a hip, modify a cap that will fit over the shingles, lock into the Eave Starter Strip and bend the end of the cap to conform to corner of the roof.

Hook four nail clips into the back flange of the cap and fasten them in place. Be certain the fasteners are long enough to penetrate solid decking. Continue to lock the caps into each other as they are installed up the hip line. Flatten shingle butts as needed to allow Ridge/Hip Caps to sit as flat as possible.

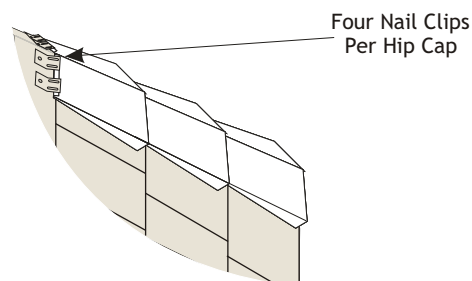

## Valley (325)

Prepare the valley by laying a full width of underlayment down the valley, using Plastic-Top Felt Nails (N-501). 325 Valley is installed in all roof valleys by use of Nail Clips (SH-409) fastened to the return flanges, 12" on centers, on each side of the Valley. Like all lineal flashings, uphill Valley should lap downhill Valley by at least 6" and be sealed with Terpolymer Butyl Sealant (VP-275). Valley should lock into the Eave Starter Strip at the eave. Trim and fold tabs to conform to the corner and fit the Eave Starter Strip.

As shingles reach a previously-installed 325 Valley, shingles are trimmed and folded into the receiving channels on each side of the Valley as follows:

- Lay the 2001 shingle in place where it will be installed into the valley and mark the shingle with a line that runs parallel to the Valley receiving channel, 1 1/8" from the channel. Cut the shingle along this mark.

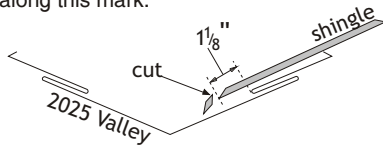

- Using hand flangers, grip the shingle 7/8" from the trimmed edge and fold a full 180° downward and back under.

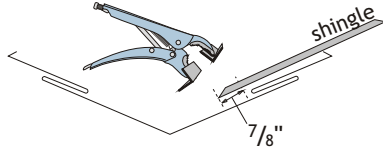

- Install the trimmed and folded shingle by locking the fold into the Valley receiving channel. Seal with a bead of Terpolymer Butyl Sealant.

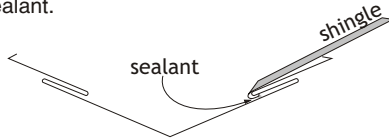

Remember to stagger succeeding courses of shingles proceeding out of a valley to the right.

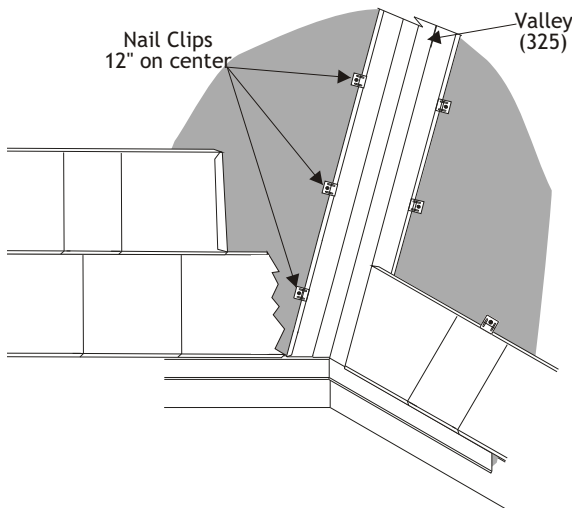

## Sidewall Flashing (2021)

Sidewall Flashing should be fastened to the roof deck with Nail Clips (SH-409) attached to the return flange 12" on center. Sidewall Flashing has a leg extending up the wall which should be inserted behind the sidewall covering. If the flashing cannot go behind the siding, nail it to the sidewall and seal, or secure to wall with a terminator bar and seal. If the sidewall is masonry, treat as chimney side flashing. Sidewall Flashing should extend 3/4" past the Eave Starter Strip at the eave. Oxford Shingles are installed into Sidewall Flashing by inserting the shingle into a receiving channel in the flashing. Remove the butt of the first shingle that covers the end of the water return channel. Be sure that no nails penetrate the water channel. All shingle nails should be driven outside this channel.

2021 Sidewall Flashing installed behind existing siding

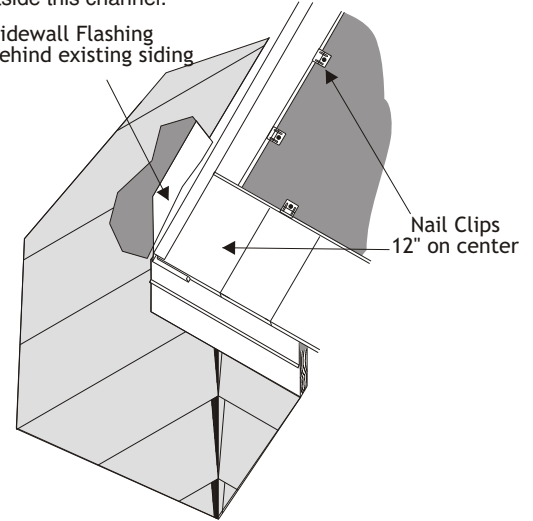

## Vent Pipe Flashing

Bring underlayment 1 1/2" up around pipe, and add an additional piece of underlayment extending 18" to each side, the downhill side of which should rest on top of the shingles beneath the vent pipe. Seal underlayment seams, especially around pipe, with roofing cement.

Install courses of shingles under the pipe until the distance between the top of the last course of shingles is less than 12 inches from the pipe. Then install shingles around the pipe. Trim as necessary, then apply a bead of sealant to the pipe.

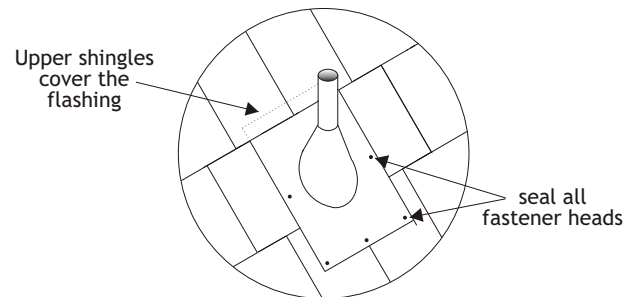

Apply a bead of sealant around the perimeter of the bottom side of the pipe boot and place it over the pipe. The top of the pipe boot should extend past the top of the top lock of the shingles. Fasten through flashing, shingles, and decking with nails or screws, sealing all heads. The next course of shingles should be installed resting on top of the pipe flashing. Trim uphill shingles to fit around pipe if necessary, and fill the holes in the shingle with sealant.

## Chimney Flashing

Make a 1/2" cut in the masonry above existing flashings, parallel to the roof deck. On the downhill side of the chimney, field-form a flashing to be received into this cut, extend down to the roof deck and 4" out on top of the installed shingles below. On sides of chimney, use 2021 Sidewall Flashing. The downhill ends of Sidewall Flashings should rest on top of the front chimney flashing. On the uphill side of the chimney, a flashing should be formed to be received into the masonry cut, extend down the back of the chimney, and rest on top of the Sidewall Flashings. The uphill portion of this flashing should lay beneath the shingles above. If the chimney is over 18" wide, the uphill side should be cricketed.

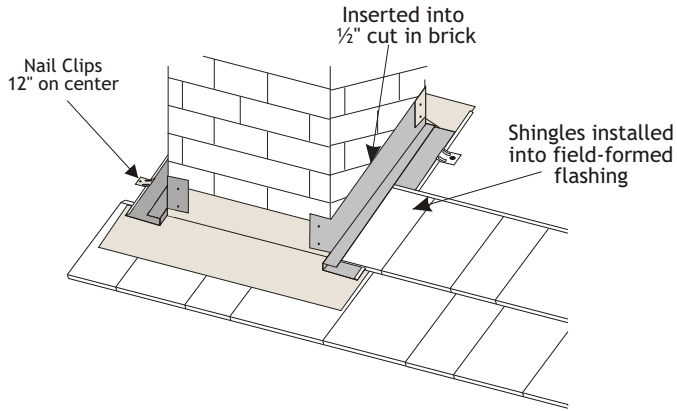

## Ridge Treatment

The ridge must be watertight before installing Ridge/Hip Caps (2007). Either: 1) bend the top course of shingles over the ridge by at least 2" or 2) field-form a flashing to make the ridge watertight.

Install a field-formed starter piece on the end of the ridge. Lock the first cap over the starter strip. Install Ridge Caps by engaging back flange into front flange of previously-installed cap. Fasten with two Nail Clips on each front flange (4 per cap). Ridge Caps may be started at both gable ends and work toward the middle, where a trimmed cap attached with sheet metal screws will join them. Seal screw heads.

Make Ridge Watertight Before Installing Ridge Caps



**-OR-**

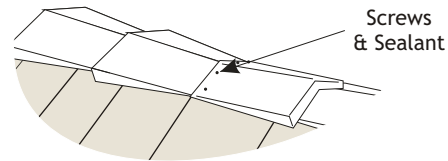
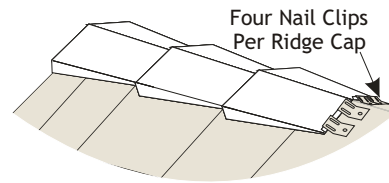
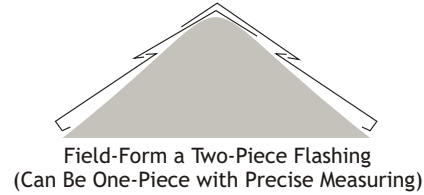

Caps Meet in Center

**CLASSIC  
PRODUCTS**  
INC.

*Performance You Can Depend On*

**1-800-543-8938**

8510 Industry Park Drive

PO Box 701

Piqua, OH 45356

Fax: 937-773-9261

[www.classicroof.com](http://www.classicroof.com)